

Technical Bulletin

Bulletin Number: 403 Revision Number: R-06

Release Date: November 19, 1990 Revision Date: July 26, 1996

SUBJECT: SERIES 90 *KEPS KITS

MODELS AFFECTED: All DNCB 1-¼" Deeper, 501T and 600T Venders.

REASONS:

1. **Tie Bar** - Installed to strengthen column walls to eliminate the possibility of cans falling from the columns when the gate is open.

2. **Plastic Gate Strips** - Designed to replace the old style metal gate.

3. **Rear Spacer** - Moved to location #22 to allow more clearance for less tendency of interlocking cans.

4. **Shims** - Redesigned to add an angle to the top of the shim to facilitate cans loading in the rotor. Also, added a shelf to the middle can position to add can retention.

5. **Screws** - Installed new 5/8" long screws to serve as a sold out paddle stop to prevent cans from touching the front of the oscillator. This reduces the chance of a front can stand up or jam.

6. **Jumpers** - Installed to require less "hold in" time of the select switch to allow the motor to take over and turn on its own.

SERIAL NUMBER BREAKS:

- A. All 1-¼" Deeper and T-Model Venders beginning serial number 0001-3193CO and up have the new cams and screws factory installed.
- B. All 501 T-Model Venders beginning serial number 0001-3197CO and up have the new wiring harness factory installed.
- C. All 600 T-Model Venders beginning serial number 0001-3204DO and up have the new wiring harness factory installed.
- D. All 1-¼" Deeper Venders serialized 0001-3198DO to 0001-3233DP and 0001-6004DO and up have the new wiring harness factory installed.
- E. All 501TR Very Fine (Circular) Venders on production run 3197CO have the new wiring harness factory installed but, an original Series 90 wiring diagram was placed on the inner door.

INDEX FOR KIT NUMBERS AND INSTALLATION INSTRUCTIONS

- A. Model 501T'sSee KEP3XP501 Instructions
Pages 3, 8, 9, 10, 11, & 12
- B. Model 600T'sSee KEP3XP600 Instructions
Pages 4, 8, 9, 10, 11, & 12
- C. Model 600T's & 501T's Jumper Wire Kits Only
Pages 5, 11, & 12
- D. Model 1-¼" Deeper..... Jumper Wire Kits Only
See KEP2XP200
Pages 6, & 13
- E. Models 1-¼" Deeper Tie Bar
Pages 7 & 8

KEP3XP501 KIT

Models Affected: DNCB 501T Series 90 Venders

Serial Breaks: Beginning serial number 0001-3197CO and up all 501T's have the new wiring harness factory installed.

For Series 90 T-Model Venders serialized 0001-3162AO to 0001-3197CO order the KEPs kit below:

KEPs Kit 3XP501 498,070,200.34

Kit Contents:

1	801,808,510.01	12" Long Single Arm Gate Strip
1	801,808,490.01	15 ½" Long Single Arm Gate Strip
2	801,808,500.01	12" Long Double Arm Gate Strip
2	801,808,480.01	15 ½" Long Double Arm Gate Strip
1	901,805,180.01	Channel Cap, Left
1	901,805,170.01	Channel Cap, Right
1	497,070,090.03	Center Tie Bar
4	901,100,520.11	Pop Rivet, Stainless Steel (1/8" x .125 - .250)
5	497,070,130.83	Can Stop Shim
13	900,301,850.01	Screw, #8-32 x 5/8"
3	804,905,040.01	Jumper Assembly, Wide Column
5	804,905,030.01	Jumper Assembly, Narrow Column
12	901,901,000.01	Cable Tie
8	904,600,540.01	Small Single Housing
2	901,100,560.01	Pop Rivet, Stainless Steel (1/8" x .251 - .375)
1	803,839,320.01	Plastic Gate Strip Label

IMPORTANT: Total installation of **all** parts in this kit is necessary to ensure enhanced performance.

INDEX

A.	Jumper Wire Installation	Pages 11 & 12
B.	New 5/8" Screw Installation	Page 10
C.	Tie Bar, Gate Strip and Shim Installation.....	Pages 8 & 9

KEP3XP600 KIT

Models Affected: DNCB 600T Series 90 Venders

Serial Breaks: Beginning serial number 0001-3204CO and up all 600T's have the new wiring harness factory installed.

For Series 90 T-Model Venders serialized 0001-3162AO to 0001-3204CO order the KEPs Kits below.

12 oz. Can KEPs Kit 3XP600 497,070,400.34

Kit Contents:

*1	801,808,530.01	19" Long Single Arm Gate Strip
*1	801,808,490.01	15 ½" Long Single Arm Gate Strip
*1	801,808,520.01	19" Long Double Arm Gate Strip
*1	801,808,480.01	15 ½" Long Double Arm Gate Strip
*1	901,805,180.01	Channel Cap, Left
*1	901,805,170.01	Channel Cap, Right
*1	497,070,090.13	Center Tie Bar
*4	901,100,520.11	Pop Rivet, Stainless Steel (1/8" x .125 - .250)
5	497,070,130.83	Can Stop Shim
*13	900,301,850.01	Screw, #8-32 x 5/8"
*3	804,905,040.01	Jumper Assembly, Wide Column
*5	804,905,030.01	Jumper Assembly, Narrow Column
*12	901,901,000.01	Cable Tie
*8	904,600,540.01	Small Single Housing
*2	901,100,560.01	Pop Rivet, Stainless Steel (1/8" x .251 - .375)
*1	803,839,320.01	Plastic Gate Strip Label

16 oz. PLB NR Glass Bottle, 16 oz. 497,070,400.24

Plastic Pet Bottle and ½ Liter
Plastic Bottle Kit

For 16 oz. Kit Contents: See Items * above.

IMPORTANT: Total installation of all parts in these kits are necessary to ensure enhanced performance.

INDEX

A.	Jumper Wire Installation	Pages 11 & 12
B.	New 5/8" Screw Installation.....	Page 10
C.	Tie Bar, Gate and Shim Installation.....	Pages 8 & 9

KEP2XPOOO
DNCB 1-1/4" DEEPER SERIES 90
JUMPER KITS ONLY

Models Affected: All DNCB 1-1/4" Deeper Series 90 Venders

Serial Breaks: All DNCB 1-1/4" Deeper Venders serialized 0001-3198DO to 0001-3233DP and 0001-6004DO and up have the new wiring harness factory installed.

For Series 90 DNCB 1-1/4" Deeper Venders serialized 0001-3162AO to 0001-3197CO and 0001-6000CO to 0001-6004DO order the KEPs kits below.

KITS

5	Column Adaptable Venders (All Wide Columns)	445,011,100.04
	<u>Kit Contents:</u>	
	5 804,905,040.01 Jumper Assembly, Wide Column	
	6 901,901,000.01 Cable Ties	
	5 904,600,540.01 Small Single Housing	
6	Column Adaptable Venders (All Wide Columns)	443,012,300.04
	<u>Kit Contents:</u>	
	6 804,905,040.01 Jumper Assembly, Wide Column	
	8 901,901,000.01 Cable Ties	
	6 904,600,540.01 Small Single Housing	
6	Column Dual Adaptable Venders (Narrow & Wide Columns)	435,011,100.04
	<u>Kit Contents:</u>	
	3 804,905,040.01 Jumper Assembly, Wide Column	
	3 804,905,030.01 Jumper Assembly, Narrow Column	
	8 901,901,000.01 Cable Ties	
	6 904,600,540.01 Small Single Housing	
8	Column Dual Adaptable Venders (Narrow & Wide Columns)	444,010,100.04
	<u>Kit Contents:</u>	
	4 804,905,040.01 Jumper Assembly, Wide Column	
	4 804,905,030.01 Jumper Assembly, Narrow Column	
	8 901,901,000.01 Cable Ties	
	8 904,600,540.01 Small Single Housing	
10	Column Dual Adaptable Venders (Narrow & Wide Columns)	437,010,200.04
	<u>Kit Contents:</u>	
	1 804,905,040.01 Jumper Assembly, Wide Column	
	9 804,905,030.01 Jumper Assembly, Narrow Column	
	10 901,901,000.01 Cable Ties	
	10 904,600,540.01 Small Single Housing	

IMPORTANT: Total installation of all parts in this kit is necessary to ensure enhanced performance.

INDEX

A. Jumper Wire Installation	Page 13
-----------------------------------	---------

**DNCB 1-1/4" DEEPER SERIES 90
TIE BARS
276'S AND 440'S**

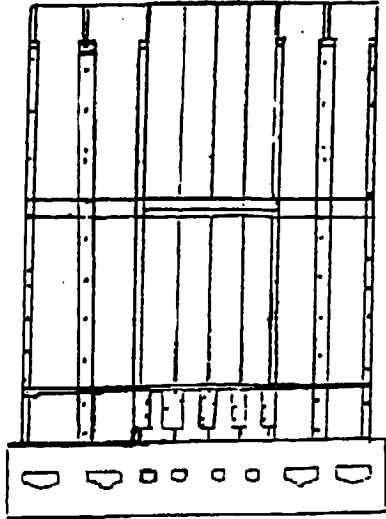
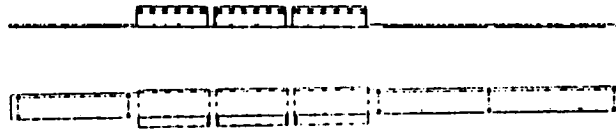
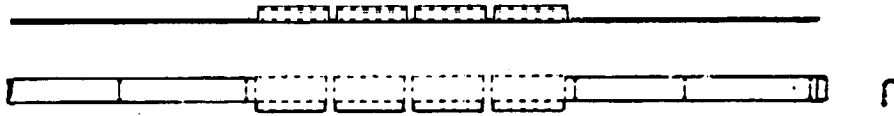

Figure 1



**Figure 2
493,070,040.03**



**Figure 3
491,070,090.03**

- | | |
|---------------------|-------------------------------|
| 1 - 493,070,040.03 | 276 Center Tie Bar, Series 90 |
| 1 - 491,070,090.03 | 440 Center Tie Bar, Series 90 |
| 12 - 901,100,520.11 | Steel Rivet |

To Install Tie Bars:

1. Remove the gate strips.
2. Place the tie bar in position aligning the slots in the tie bar with the column walls.
3. Push the bar in position.
4. Secure the tie bar with pop rivets to the hem channels of the stack.
5. Measure the distance above the tie bar to the top of the hem channels, cut the gate strips, and install.
6. Measure the distance below the tie bar to the top of the front mech plate, cut the gate strips, and install.

TIE BAR, GATE, AND SHIM INSTALLATION:

***Total installation of all components in this kit is essential to ensure enhanced performance.**

1. **UNPLUG THE VENDER.**
2. Read all instructions before continuing.
3. Wear safety glasses while removing and installing kit.
4. With the gate in its closed and latched position, remove the top gate hinge (See section "A", figure 4, pg. 9) by chiseling the heads from the two pop rivets that secure it. Discard the hinge. **CAUTION: Wear safety glasses.**
5. Remove the old gate and discard.
6. Remove top and bottom gate latches. (See section "B", figure 4, pg. 9) by chiseling the heads from the two pop rivets that secure it. Discard the latch.
7. Remove the bottom gate hinge (see section C, figure 4, pg. 9) by chiseling the heads from the two pop rivets that secure it.
8. Locate the center tie bar from the kit. (See figures 6 and 7, pg. 9.)
9. Align the slots in the tie bar with the column walls.
10. Push the bar in position.
11. Align the screw slots in the end of the tie bar with the holes in the stack where the top gate latch was removed.
12. Secure the latch side of the tie bar with two pop rivets.
13. Align the screw slots in the end of the tie bar with the holes in the stack where the top gate hinge was removed.
14. Secure the hinge side of the tie bar with two pop rivets.
15. Install the new gate strips. (See figures 9, 10, & 11, pg. 9.)
16. Install the plastic gate strip labels (#803,839,320.01) on the inner door.
17. Remove existing can stop shims from the right side of each narrow column.
18. Install one of the new can stop shims in each column (See figure 8, pg. 9.)
19. Move all rear spacers to hole #22 at the top and bottom.

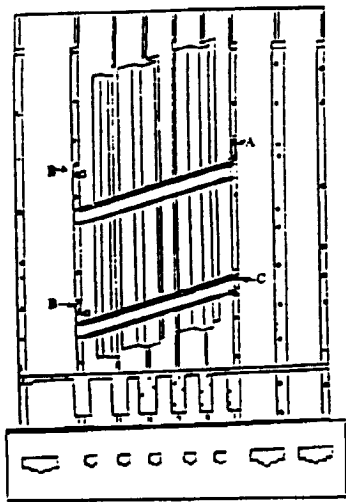

Figure 4

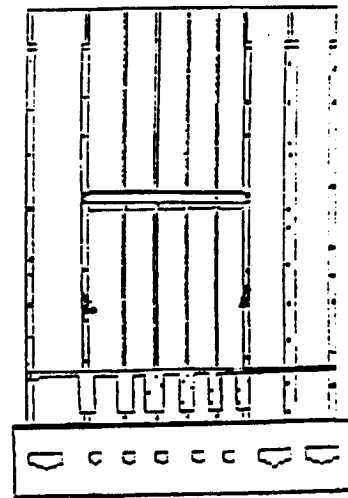

Figure 5

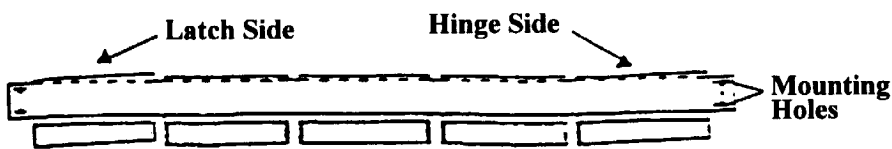

Figure 6
Tie Bar (Front View)

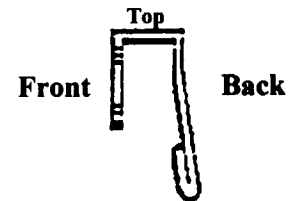

Figure 7
Tie Bar (Side View)

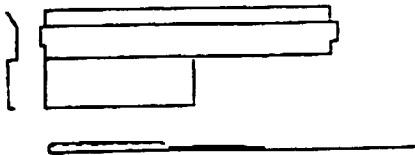

Figure 8
Can Stop Shim

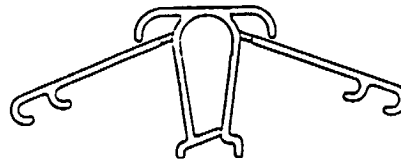

Figure 9
Double Arm Gate Strip

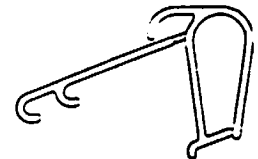

Figure 10
Single Arm Gate Strip

Open Position

Unload Position

IMPORTANT:

EXTRUSION MUST BE IN THE OPEN POSITION WHEN VENDING PRODUCT OR JAMS WILL RESULT.

PLASTIC GATE EXTRUSIONS ARE NOT REVERSIBLE. ONCE INSTALLED, IT SHOULD NOT BE NECESSARY TO REMOVE EXTRUSION. HOWEVER, IF REMOVED FOR ANY REASON, THE EXTRUSION MUST BE INSTALLED SUCH THAT THE LIP LOCKS ON COLUMN WALL HEM AS SHOWN.

EXTRUSION MAY BE SNAPPED DOWN TO EASE LOADING. UNSNAP AND RETURN TO OPEN POSITION FOR VENDING

804,839,320.01

Figure 11
Plastic Gate Strip Label
(placed on inner door)

SCREW INSTALLATION:

1. Narrow Columns See figure 12 below.
 - a. Remove the top two (2) screws that secure the narrow column vend motor to the stack.
 - b. Install the two (2) new screws (#8-32 x 5/8") in place of the screws removed in Step 1a.

2. Wide Columns See figure 13 below.
 - a. Look at the wide column vend motor.
 - b. Locate the hole in the front plate mechanism, of the stack, immediately above the vend motor. See figure 13.
 - c. Install one (1) screw (#8-32 x 5/8") in the hole.

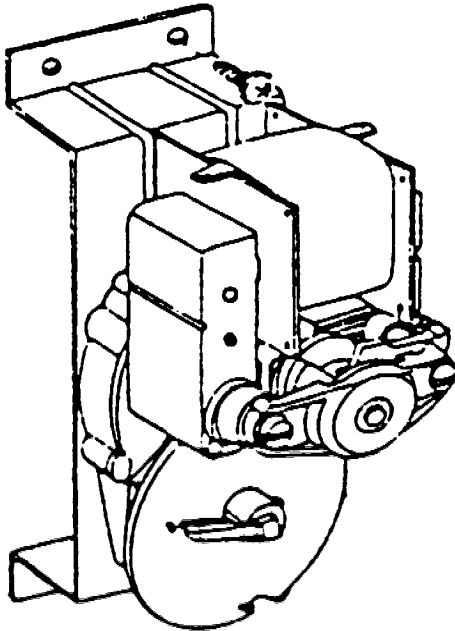

Figure 12

Install New
Sems Screw
Here → ○

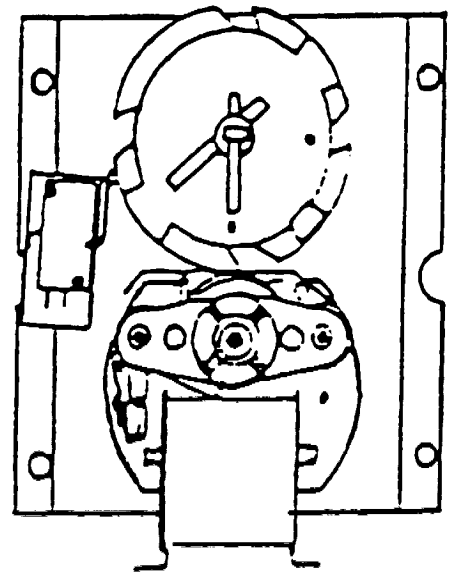
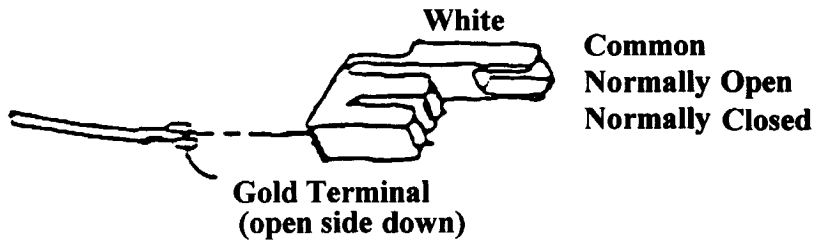
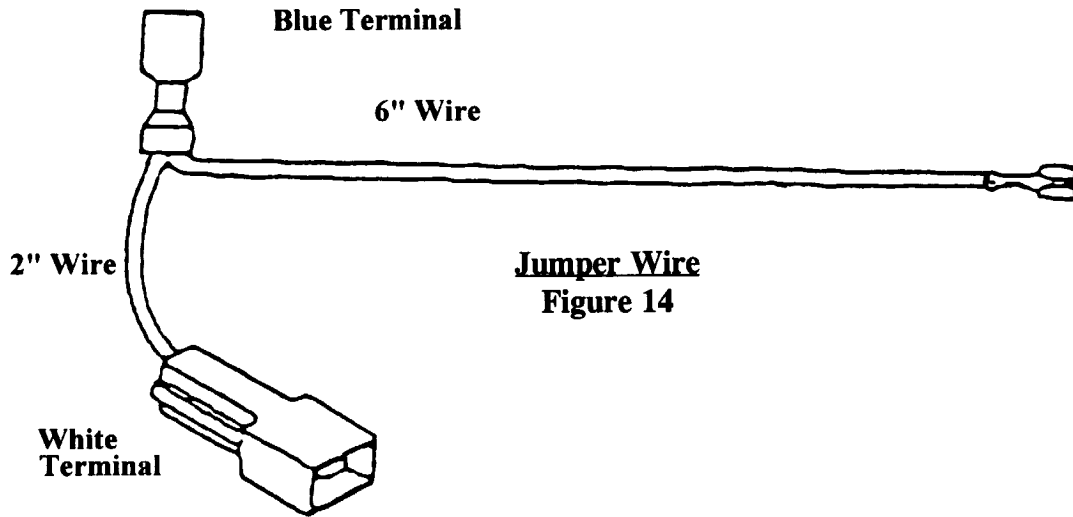

Figure 13

T-MODEL JUMPER WIRE INSTALLATION:

1. Read the instructions thoroughly before starting.
2. **UNPLUG THE VENDER.**
3. Remove the motor cover.
4. Remove the vend motor switch housing (red) and the bypass switch housing (white) from the switch assemblies on all the vend motors.
5. Remove the terminal from the normally closed side of the vend motor switch. See figure 17, pg. 12. To remove the terminal, see the terminal removal instructions on page 12. See figure 18, pg. 12.
6. Insert the terminal removed in step 5 in the small housing supplied with the kit. See figure 16, pg. 12.
7. Note: For steps 8, 9, 10 and 11 do one motor at time.
8. **VERY IMPORTANT:** Remove the following leads from the vend motor coil terminals one at a time.
Column #1 wire #80, column #2 wire #82, column #4 wire #84, column #5 wire #86, column #6 wire #88, column #7 wire #90, column #8 wire #92 and column #3 wire #94.
9. Install the wire removed in step 8 in the white terminal of the jumper supplied with the kit. See figure 14, pg. 12.
10. Push the blue terminal of the jumper, supplied with the kit, on the vend motor coil terminal. See figure 14, pg. 12.
11. Insert the gold terminal of the jumper in the normally closed position of the by-pass switch housing. See figures 14 & 15, pg. 12.
12. Repeat steps 8 through 11 for all motors, paying close attention to the wire numbers called out in step 7.
13. Wire tie the small single housings (figure 16, pg. 12) to the existing harness. The small single housings do not plug on any switches.
14. Install the vend motor switch housing to the position on the switch assembly that it was removed from in step 4.
15. Install the by-pass switch housing to the position on the switch assembly that it was removed from in step 4.
16. Place the vend motor cover back in place and secure.
17. Plug in the vender and test for proper operation.



ByPass Switch Housing
Figure 15

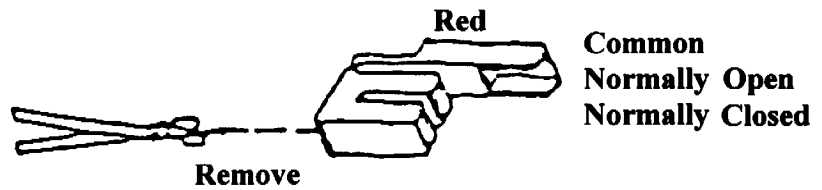
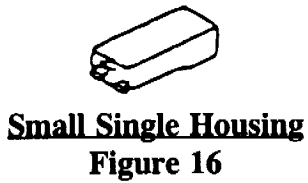

Motor Switch Housing
Figure 17

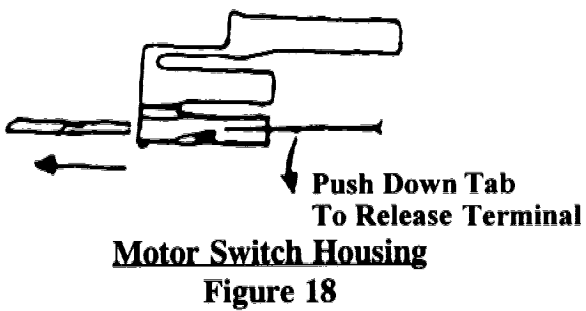

1-1/4" DEEPER JUMPER WIRE INSTALLATION:

1. Read the instructions thoroughly before starting.
2. **UNPLUG THE VENDER.**
3. Remove the motor cover.
4. Remove the vend motor switch housing (red) and the by-pass switch housing (white) from the switch assemblies on all the vend motors.
5. Remove the terminal from the normally closed side of the vend motor switch. See figure 17, pg. 12. To remove the terminal see the terminal removal instructions on page 12. See figure 18, pg. 12.
6. Insert the terminal removed in step 5 in the small housing supplied with the kit. See figure 16, pg. 12.
7. Note: For steps 8, 9, 10 and 11 do one motor at a time.
8. **VERY IMPORTANT:** Remove the following leads from the vend motor coil terminals one at a time. Starting with the far right column (column 1) and going right to left the wire numbers to be removed are 80, 82, 84, 86, 88, 90, 92, 94, 186 and 188.
9. Install the wire removed in step 8 in the white terminal of the jumper supplied with the kit. See figure 14, pg. 12.
10. Push the blue terminal of the jumper, supplied with the kit, on the vend motor coil terminal. See figure 14, pg. 12.
11. Insert the gold terminal of the jumper in the normally closed position of the by-pass switch housing. See figures 14 and 15, pg. 12.
12. Repeat steps 8 through 11 for all motors, paying close attention to the wire numbers called out in step 7.
13. Wire tie the small single housings (figure 16, pg. 12) to the existing harness.
14. Install the vend motor switch housing to the position on the switch assembly that is was removed from in step 4.
15. Install the by-pass switch housing to the position on the switch assembly that it was removed from in step 4.
16. Place the vend motor cover back in place and secure.
17. Plug in the vender and test for proper operation.